



### BC846S DUAL TRANSISTOR (NPN+NPN)

#### FEATURES

- Two transistors in one package
- Reduces number of components and board space
- No mutual interference between the transistors

#### MARKING: 4Ft

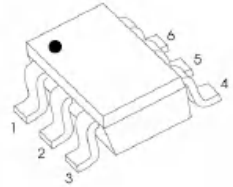
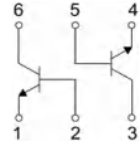

#### MAXIMUM RATINGS( $T_a=25^{\circ}\text{C}$ unless otherwise noted)

Symbol	Parameter	Value	Units
$V_{CBO}$	Collector-Base Voltage	80	V
$V_{CEO}$	Collector-Emitter Voltage	65	V
$V_{EBO}$	Emitter-Base Voltage	6	V
$I_C$	Collector Current –Continuous	0.1	A
$P_C$	Collector Dissipation	200	mW
$T_J, T_{stg}$	Operation Junction and Storage Temperature Range	-55~+150	$^{\circ}\text{C}$

SOT-363

#### ELECTRICAL CHARACTERISTICS ( $T_a=25^{\circ}\text{C}$ unless otherwise specified)

Parameter	Symbol	Test conditions	Min	Typ	Max	Unit
Collector-base breakdown voltage	$V_{(BR)CBO}$	$I_C=10\mu\text{A}, I_E=0$	80			V
Collector-emitter breakdown voltage	$V_{(BR)CEO}$	$I_C=10\text{mA}, I_B=0$	65			V
Emitter-base breakdown voltage	$V_{(BR)EBO}$	$I_E=10\mu\text{A}, I_C=0$	6			V
Collector cut-off current	$I_{CBO}$	$V_{CB}=30\text{V}, I_E=0$			15	nA
Emitter cut-off current	$I_{EBO}$	$I_C=0, V_{EB}=5\text{V}$			500	nA
DC current gain	$h_{FE}$	$V_{CE}=5\text{V}, I_C=2\text{mA}$	200		450	
Collector-emitter saturation voltage	$V_{CE(sat)(1)}$	$I_C=10\text{mA}, I_B=0.5\text{mA}$			0.1	V
	$V_{CE(sat)(2)}$	$I_C=100\text{mA}, I_B=5\text{mA}$			0.3	V
Base-emitter saturation voltage	$V_{BE(sat)}$	$I_C=10\text{mA}, I_B=0.5\text{mA}$		0.77		V
Transition frequency	$f_T$	$V_{CB}=5\text{V}, I_E=10\text{mA}, f=100\text{MHz}$	100			MHz
Collector output capacitance	$C_{ob}$	$V_{CB}=10\text{V}, I_E=0, f=1\text{MHz}$			1.5	pF

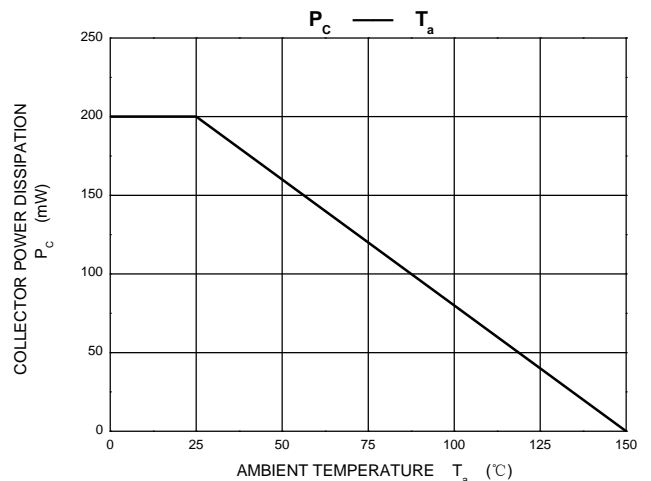
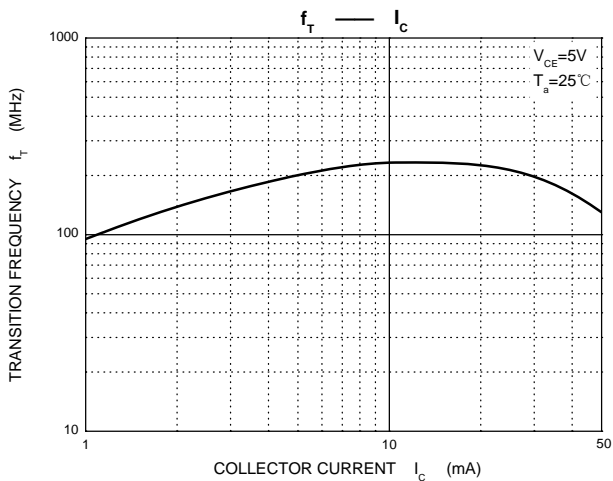
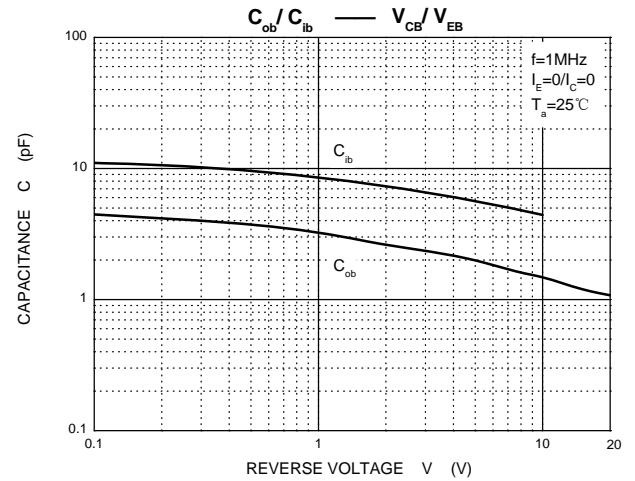
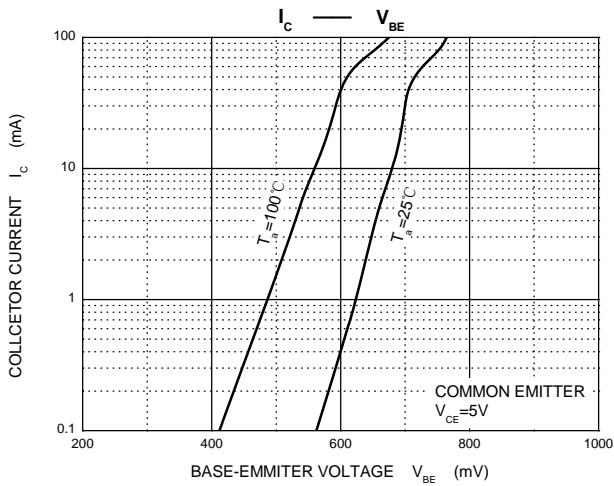
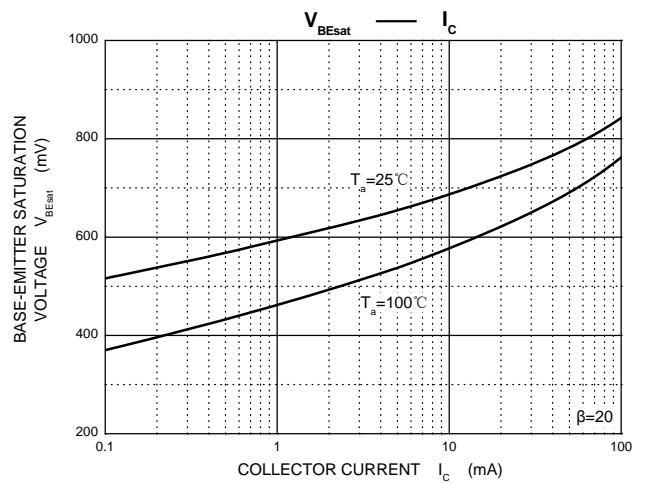
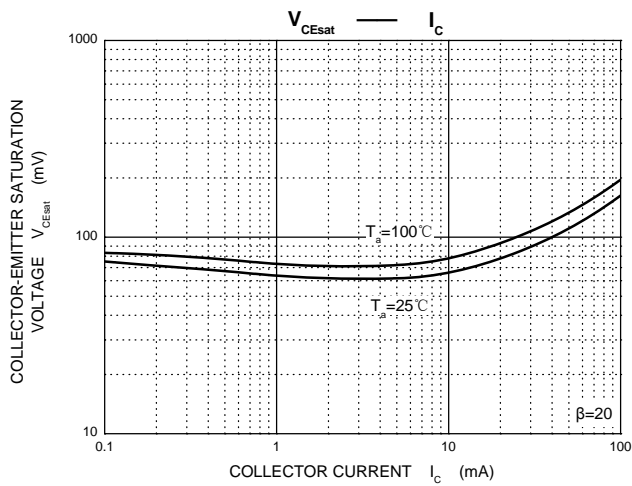
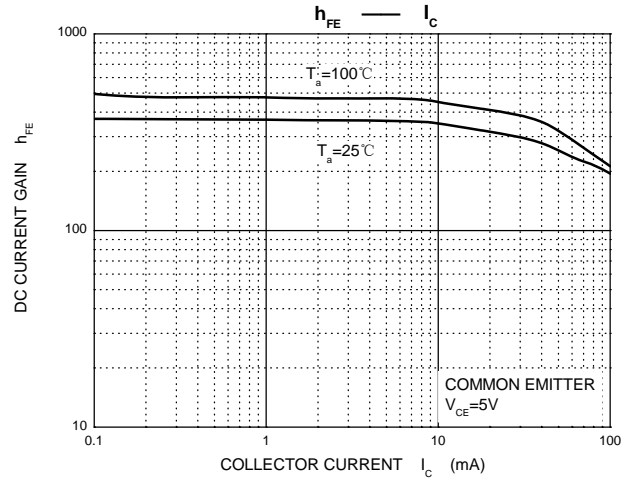
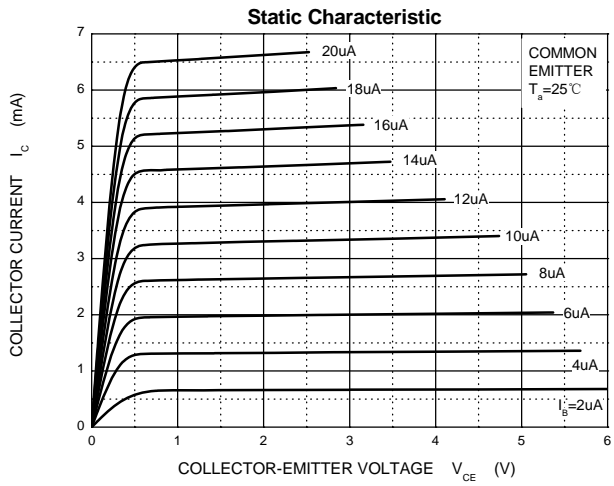



## SOT-363 Package outline dimensions

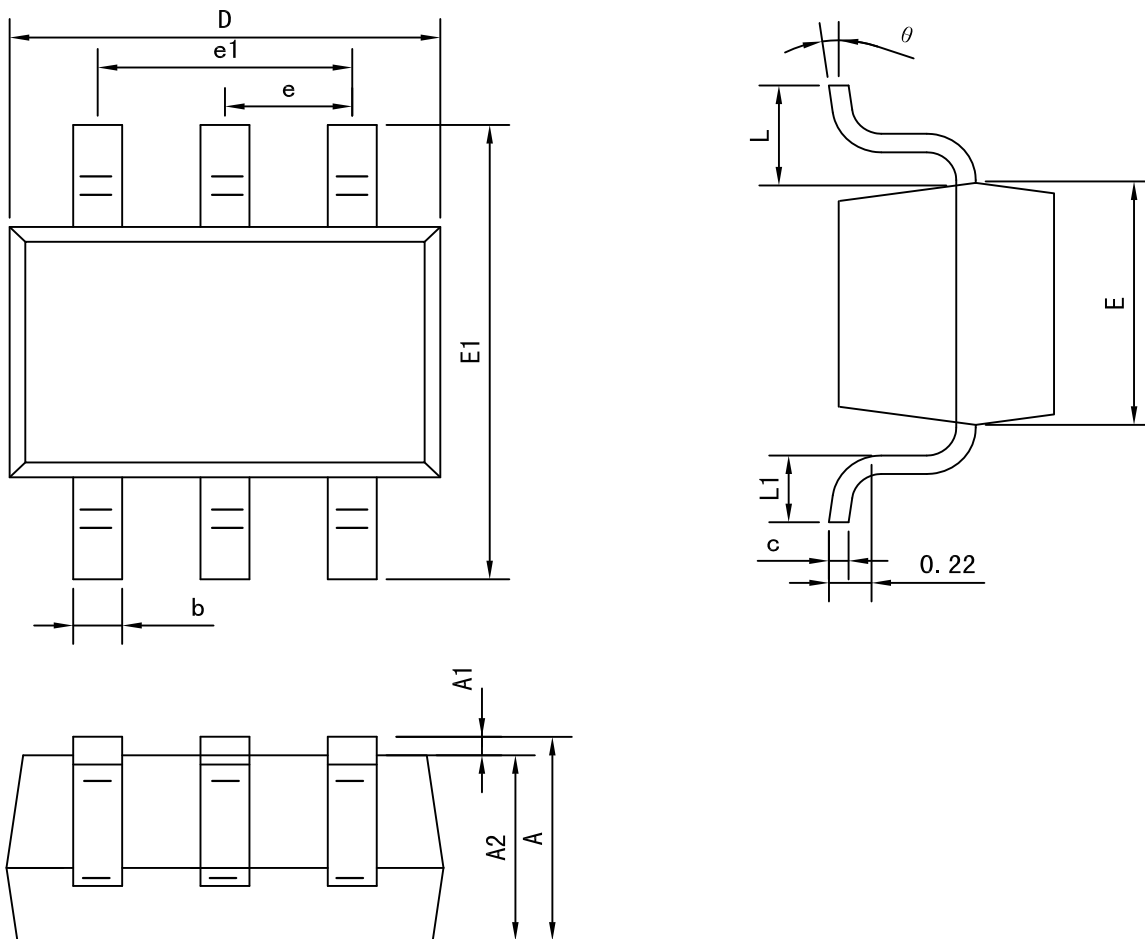

Symbol	Dimension in Millimeters	
	Min	Max
A	0.900	1.100
A1	0.000	0.100
A2	0.900	1.000
b	0.150	0.350
c	0.080	0.150
D	2.000	2.200
E	1.150	1.350
E1	2.150	2.450
e	0.650 TYP	
e1	1.200	1.400
L	0.525 REF	
L1	0.260	0.460
$\theta$	0°	8°



### SOT-363 Embossed Carrier Tape

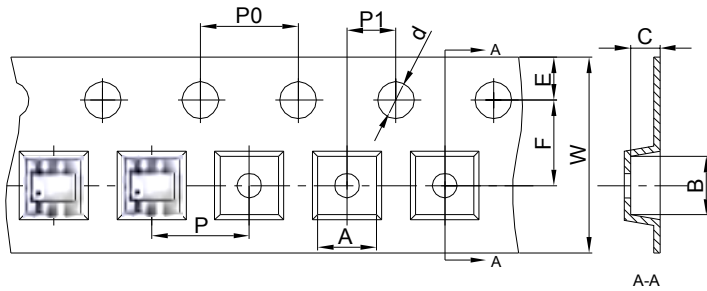

#### Packaging Description:

SOT-363 parts are shipped in tape. The carrier tape is made from a dissipative (carbon filled) polycarbonate resin. The cover tape is a multilayer film (Heat Activated Adhesive in nature) primarily composed of polyester film, adhesive layer, sealant, and anti-static sprayed agent. These reeled parts in standard option are shipped with 3,000 units per 7" or 17.8cm diameter reel. The reels are clear in color and is made of polystyrene plastic (anti-static coated).

Dimensions are in millimeter										
Pkg type	A	B	C	d	E	F	P0	P	P1	W
SOT-363	2.25	2.55	1.20	Ø1.50	1.75	3.50	4.00	4.00	2.00	8.00

### SOT-363 Tape Leader and Trailer

